

Dear customer,

Congratulations!

You have chosen the best product we know how to make with our 30 years of experience and passion for precision.

Please follow the instructions in this manual to avoid mistakes and save time.

In case you need further information or you have further requests we will be glad to be at your disposal.

With best regards

Your GRIP GmbH

GRIP GmbH Handhabungstechnik

Alter Hellweg 70  
44379 Dortmund, Germany

Tel. +49 231 96450 01  
Fax +49 231 96450 50

info@grip-gmbh.com  
www.grip-gmbh.com

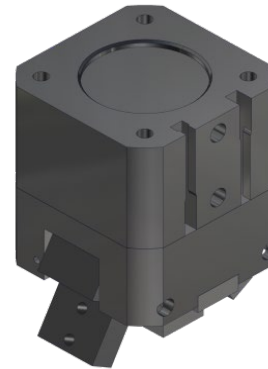

## GZ Pincer Gripper

	<b>Contents</b>	<b>Page</b>
<b>1</b>	Operation	2
<b>2</b>	Safety	2
	<b>2.1</b> Symbol	2
	<b>2.2</b> Intended use	2
	<b>2.3</b> Environmental and operating conditions	2
	<b>2.4</b> Safety indication	2
<b>3</b>	Warranty	3
<b>4</b>	Scope of delivery	3
<b>5</b>	Technical data	3
<b>6</b>	Assembly	3
<b>7</b>	Maintenance and care	4
	<b>7.1</b> Disassembly	4
	<b>7.2</b> Torque specifications	4
	<b>7.3</b> Compressed air connection	4
<b>8</b>	Parts list	5
	<b>8.1</b> Spare and wear parts	5
<b>9</b>	Exploded view	6
<b>10</b>	EC-Declaration of incorporation	7

## 1 Operation

The pincer gripper (GZ) is powered by an eccentric drive, ensures the highest service life and provides a constant gripping moment over the entire opening and closing angle range of the fingers. Depending on the ordered version, the gripper is equipped with a gripping force safety device.

## 2 Safety

### 2.1 Symbol



This symbol indicates possible hazards to persons or the GZ Pincer Gripper.

### 2.2 Intended use

The GZ Pincer Gripper series is designed for gripping and securely holding work pieces or objects. The system is intended for the installation in a machine. The requirements of the applicable instructions must be considered and adhered to. The unit may only be used in the context of its technical specifications.

### 2.3 Environmental and operating conditions

Use this unit only in dry and splash-proof environments at room temperature as well as within the application parameters defined in the technical specifications. If this is not the case, warranty cannot be accepted. Exceptions are units designed especially for the respective conditions.

### 2.4 Safety indication

Dangers may arise from the unit, if:

- the product is not installed or inserted properly,
- the system is not used for its intended purpose,
- the safety and installation notes are not observed.

Everyone who is responsible for assembly, commissioning and maintenance must read and understand the complete operating instructions. Improper use, which affects the function and operational safety of the GZ Pincer Gripper, is prohibited.



#### **NOTICE!**

**The unit may only be operated if the machine in which the unit is installed complies with the relevant provisions of the Machinery Directive 2006-42-EC.**



#### **CAUTION!**

**Before conducting assembly-, structural alteration-, maintenance- and installation work remove the power supply and conduct the necessary work outside the danger zone.**

### 3 Warranty

If the product is used as intended in 1-shift operation the warranty is valid for 24 months from the ex-works delivery date under observance the mandatory maintenance and lubrication intervals and the given operating conditions. Generally parts touching the work piece and wear parts are not part of the warranty. Wear parts are listed in chapter 8.1. The unit is considered to be defective if its basic function "gripping" is no longer functioning.

### 4 Scope of delivery

- GZ as painted in Image 1 and Image 4.

### 5 Technical Data

Behold technical data sheets: TD-GZ050-EN, TD-GZ063-EN, TD-GZ080-EN, TD-GZ100-EN, TD-GZ125-EN

### 6 Assembly

The assembly and maintenance work on the gripper may be performed only by authorized personnel.



#### CAUTION!

Risk of injury if the machine starts unexpectedly!

→ **Switch off the power supply!**



The gripper is mounted on the upper mounting surface by four screws. The gripper is equipped with a drilling pattern according to ISO 9409.

The user-specific gripper fingers, which is not included in the scope of delivery, are fitted with 2 screws each to the bolt. For a high degree of process reliability, we recommend the use of a screw-type safety device during assembly.

The gripper has a compressed air inlet at position 1: "open gripper", as well as at pos. 2: "close gripper". The connection diameters of the respective size can be found in the technical data.

The air connections are not included in the scope of delivery.

**Compressed air quality:** Filtered, unlubricated and dried compressed air with a permissible particle size max. 40µm.

Image 1

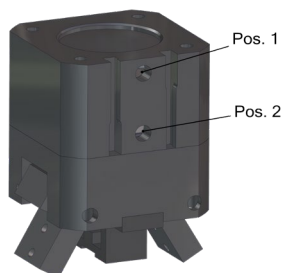
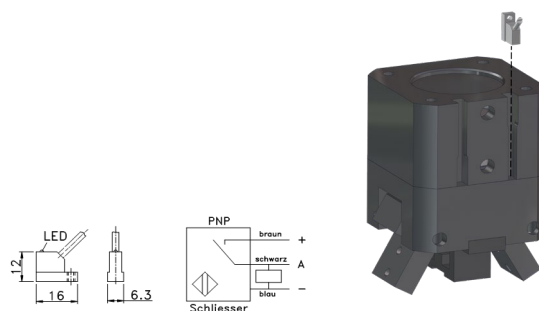

Image 2



## Sensor

The gripper is prepared for the use of a proximity switch, which is not included in the scope of delivery. The sensors are to be ordered separately. You can find them in our product catalog under the designation ZG-RSGU01. The sensor has a 2 m long cable with open ends and can be connected via terminal contacts.

To mount the proximity switches, slide them into the axial groove of the gripper housing (see figure on the left). There is a groove for the position "gripper open" and "gripper closed". The sensor can be fixed via the screw with a hex wrench in the desired switching position.

## Adjust the opening angle

By means of a central end stop, the opening angle of the gripper flanges can be infinitely adjusted in a range from 0 to 60°. Proceed as follows:

A tapped bore is provided on the lower part of the gripper to accommodate an adjusting screw.

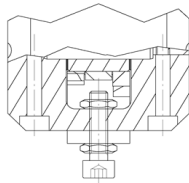

The opening angle of the gripper can be adjusted by turning the adjusting screw in or out. Then the set screw must be secured by a locknut in the adjusted position. The adjusting screw as well as the lock nut are not included in the scope of delivery and should be provided by the customer. The thread data for the central stop can be found in the following table.

Installation size	050	063	080	100	125
Screw thread $\varnothing$	M4	M5	M5	M8	M10

## 7 Maintenance and care

For the gripper there are no periodicity of maintenance provided. The unit is maintenance-free.



### Caution when opening, the system is spring preloading!

Through the spring pre-load of the system improper opening can lead to injuries. Therefore, repairs should only be carried out by the manufacturer.

### 7.1 Disassembly of the GZ

(behold Image 3)

1. Remove the GZ and disconnect it from the compressed air supply.
2. Loosen the cylinder screws completely (pos. 13).
3. Remove the cylinder (pos. 1).
4. To disassemble the piston (pos.6) with the components (pos. 3, 4, 5, 7) and power unit (pos. 8), loosen the countersunk screw (pos. 2).
5. Remove bolt (pos. 12) from the housing (pos. 11).
6. If necessary, remove the seals (pos. 9 and 10) from the housing (pos 11).
7. If necessary, remove cylindrical pin (pos. 20) and setscrews to disassemble the finger (pos. 19) with components (pos. 17 and 18).
8. Clean all parts thoroughly. Inspect for wear and defects.
9. Lubricate all mating surfaces.

For assembly, reverse the order.

### 7.2 Torque specifications

M6 – 8,5 Nm; M8 – 20,6 Nm; M10 – 41 Nm; M12 – 71 Nm

### 7.3 Compressed air connection

Requirements for compressed air according to ISO 8573-1: 6 4 4.

**8 Parts list**

Pos.	Description	Quantity
1	Cylinder ISO	1
2	Counter sunk screw, zincked	1
3	Piston cover	1
4	Magnetic ring	1
5	Sealing ring 1	1
6	Piston	1
7	Pressure spring	1
8	Power unit	1
9	Sealing ring 2	1
10	O- Ring	1
11	Housing	1
12	Cylindrical pin finger	2
13	Cylinder screw housing	4
14	Stop	1
15	Cylinder screw stop	2
16	Setscrew power unit	2
17	Sinter bronze connection	4
18	Eccentric	2
19	Finger	2
20	Cylindrical pin eccentric	1

**8.1 Spare and wear parts, depending on size**

Pos.	Description	Order-No.	Quantity
21	Signal transmitter with LED (see image 2)	ZG-RSGU01	2
22	Gasket kit for grippers (not depicted)	EG-GG...-DS	1

9 Exploded view

Pincer gripper - gripping force safety device **closing**  
G-Z...-I...-GS

Image 3

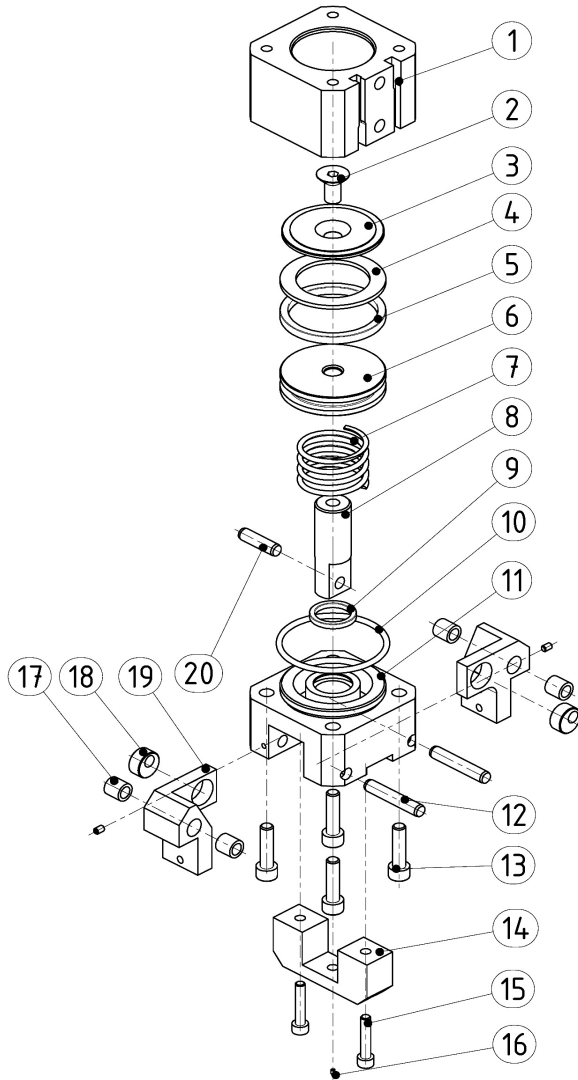
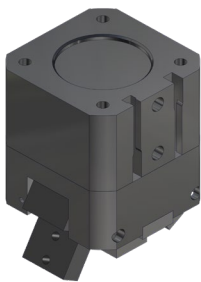

Image 4



**10 EC - Declaration of incorporation**

according to the Machinery Directive 2006/42/EC, annex II B

The producer / distributor GRIP GmbH Handhabungstechnik  
Alter Hellweg 70  
D-44379 Dortmund, Germany

hereby declares that the following products

**Product designation:** Pincer gripper (GZ)

**Functional description:** System for gripping and holding components safely

**Type designation:** G-GZ050 to 125

The provisions of the above-mentioned directives - including their effective amendments - comply with the time of the declaration.

He further states that the following essential requirements of the Machinery Directive 2006/42/EC were applied and observed:  
annex I, numerics: 1.1.2; 1.1.3; 1.1.5; 1.3.2

He further states that the specific technical documentation has been drawn up in accordance with annex VII, Part B.

The following harmonized standard has been applied:

EN ISO 12100:2010 Safety of Machinery- Basic concepts, general principles for design- Part 1:  
Basic terminology and methodology

Safety of Machinery- Basic concepts, general principles for design- Part 2:  
Technical principles

In the case of reasoned requests, the specific documents shall be sent to the national authorities as follows: Post

The product mentioned above may only be put into operation if it has been established applicable that the unit, into which the above-mentioned product is to be incorporated, complies with the provisions of the Machinery Directive 2006/42 / EC.

Authorized representative: Dipl.-Ing. (FH) Hasan Canti

Location: Dortmund  
Date: 13.09.2020

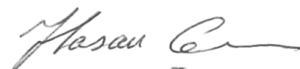

Dipl.-Ing. (FH) Hasan Canti  
Executive Director