

G-MEK063-R

Technical specifications



Operation mode:

The MEK upper assembly (1) is mounted on the MGW or SWS upper assembly. The MEK lower assembly (2) fits onto the MGW or SWS lower assembly. The MEK is automatically coupled by the mechanical connection of the change system.

Advantages:

Mechanical, pneumatic and electric connections are established simultaneously.

Can withstand 50,000 alternating cycles

Individual wiring

Coding of the interchangeable parts

Improved electrical connection by spring mounted poles

Automatic closing of pneumatic ducts by integrated check valves



Technical specifications		MEK063-R
Suitable for		MGW063, SWS063
Pneumatic ducts	number P	4
	nominal width NW [mm]	PR4
	operating pressure p [bar]	-1 to 8
Electrical ducts	no. of poles E	12
	rated current I [A]	2
	rated voltage U (max. voltage) [V]	63 (120)
	contact resistance per pole R [mΩ]	<20
	contact durability (cycles)	50.000
Mass [kg]	upper assembly	0,11
	lower assembly	0,06
Protection class (higher requirement only on request)		IP40
Operating temperature range [°C]		-30 to +120

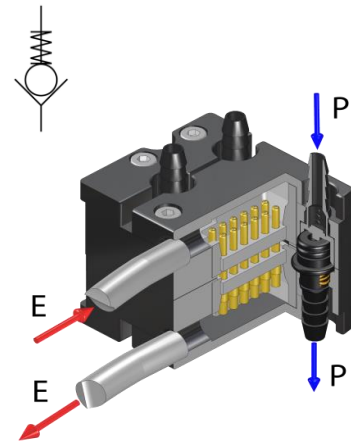

Pos.	Description
1	Upper assembly
2	Lower assembly
3	Upper cover
4	Lower cover
5	Insulation frame
6	Electrical bushing strip
7	Electrical plug strip
8	Female coupling (check valve)
9	Male coupling
10	Mounting screw
11	Mounting screw
12	Index pin
13	Cable (optional)

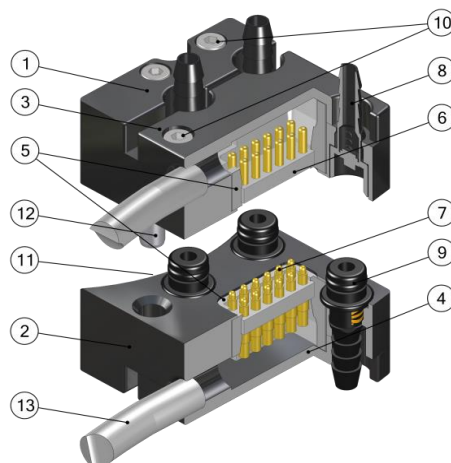

Multi energy coupling Ø63 with check valve

G-MEK063-O-4PR4	upper assembly, 4 x air with check valve, ID = 4 mm
G-MEK063-O-4PR4-1FE12	upper assembly, 4 x air with check valve, ID = 4 mm, el. socket for suspension, 12 pol.
G-MEK063-O-4PR4-1FE12-2000OE	upper assembly, 4 x air with check valve, ID = 4 mm, el. socket for suspension, 12 pol., 2000 mm cable, open end
G-MEK063-O-4PR4-1FE12-300-M12	upper assembly, 4 x air with check valve, ID = 4 mm, el. socket for suspension, 12 pol., 300 mm cable, M12 circular plug-in connector
G-MEK063-U-4PR4	lower assembly, 4 x air, ID = 4 mm
G-MEK063-U-4PR4-1FE12	lower assembly, 4 x air, ID = 4 mm, spring mounted electrical plug, 12 poles
G-MEK063-U-4PR4-1FE12-2000OE	lower assembly, 4 x air, ID = 4 mm, spring mounted electrical plug, 12 poles, 2000 mm cable, open end
G-MEK063-U-4PR4-1FE12-300-M12	lower assembly, 4 x air, ID = 4 mm, spring mounted electrical plug, 12 poles, 300 mm cable, M12 circular plug-in connector

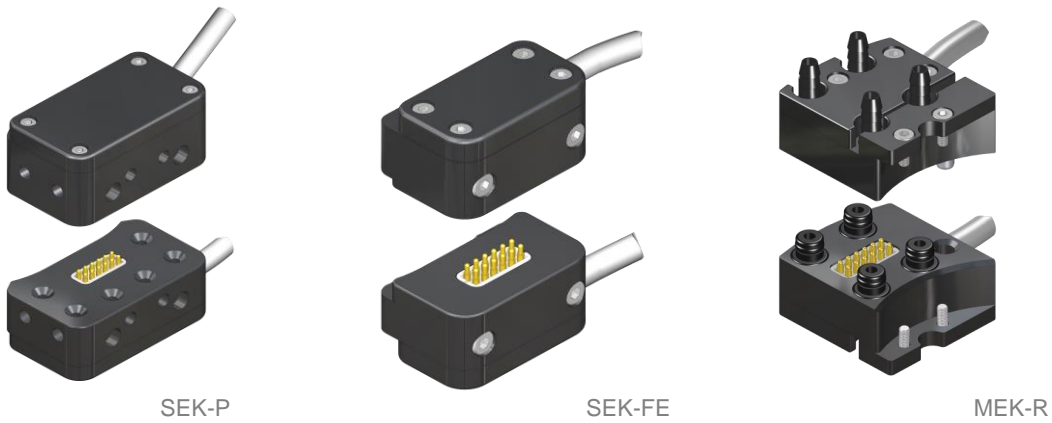

Products	Electrical connection	Cable variants
SEK-P / SEK-FE / MEK-R upper assembly	Electric strip, female (suitable for spring contacts)	M8-bushing, M12-plug, open end
SEK-P / SEK-FE / MEK-R lower assembly	Electric strip, male (including spring contacts)	M8-plug, M12-bushing, open end

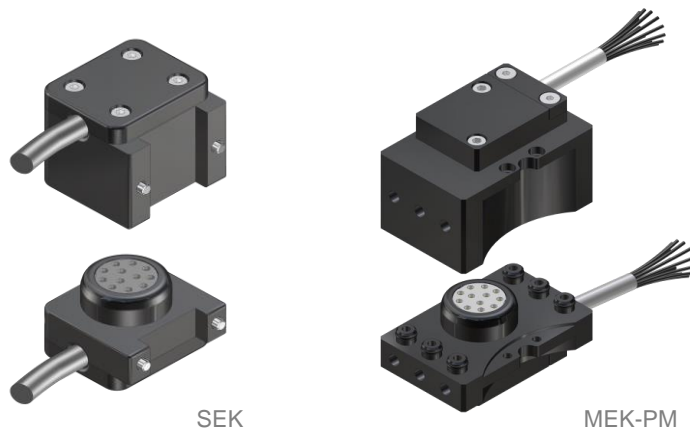

Products	Electrical connection	Cable variants
SEK / MEK-PM upper assembly	Insulating body with pin contacts	M8-bushing, M12-plug, open end
SEK / MEK-PM lower assembly	Insulating body with socket contacts	M8-plug, M12-bushing, open end



As standard, we offer the listed products for self-soldering.
The contact assignment of the pre-assembled connections can be found in the following data sheets.

Ordering example: G-SEK100-O/U-1FE12
G-MEK063-O/U-6PM5-1E12

FEB12	
Electric strip, female	
12-poles (female)	
Strip 2x 6 rows	
Rated current per pole: 2A	
Contact resistance < 20mΩ	
Contact spacing: 2,54mm	
Gilded	
Solder connection	

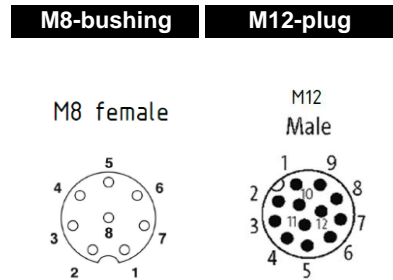
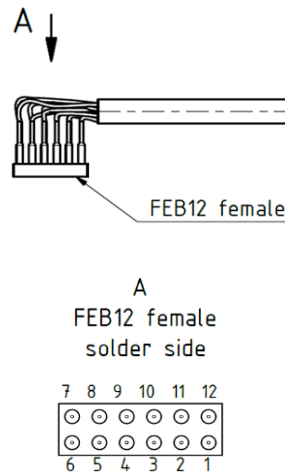

300-M8
300mm cable, circular connector M8-bushing



pin assignment	
1	white
2	brown
3	green
4	yellow
5	grey
6	pink
7	blue
8	red
9	---
10	---
11	---
12	---

M8-bushing
8 poles (female)
Cable: drag chain suitable
According to IEC-61076-2-104
Operating voltage: max 30 V
Rated current (at 30°): 1,5 A
Temperature range: -25...85°C
Cable: PUR halogen-free

included in: G-SEK100-O-1FE12-300-M8
G-MEK063-O-4PR4-1FE12-300-M8

spare part: EG-MEK-FEB12-300-M8-BW

300-M12
300mm cable, circular connector M12 plug

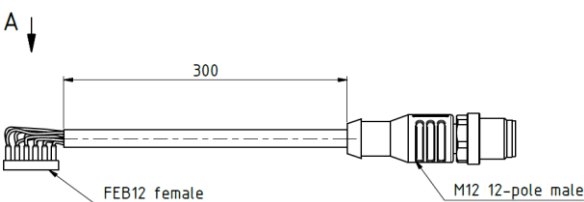

FEB12 female	colour	M12 male
1	white	3
2	brown	1
3	green	4
4	yellow	6
5	grey	8
6	pink	5
7	blue	2
8	red	9
9	black	7
10	violet	10
11	grey/pink	11
12	blue/red	12

M12-plug
12 poles (male)
Cable: drag chain suitable
12 x 0,14mm ² , Ø5,6
According to IEC-61076-2-104
Operating voltage: max 30 V
Rated current (at 30°): 1,5 A
Insulation resistance: ≥10 ³ Ω
Temperature range: -25...85°C
Cable: PUR halogen-free

included in: G-SEK100-O-1FE12-300-M12
G-MEK063-O-4PR4-1FE12-300-M12

spare part: EG-MEK-FEB12-300-M12

2000-OE
2000mm cable, open end

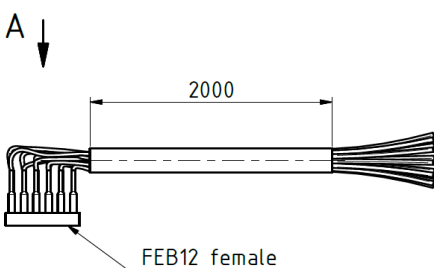

pin assignment	
1	white
2	brown
3	green
4	yellow
5	grey
6	pink
7	blue
8	red
9	black
10	violet
11	grey-pink
12	blue-red

Open end
12 poles
Cable: drag chain suitable
Outer-Ø (D): 5,6 ± 0,2mm
Nominal voltage: ≤300V
Bending radius:
- fixed installation: >5 x D
- in motion: >10 x D
Wire cross-section: 12 x 0,14mm ²
Insulation resistance: ≥10 ³ Ω
Temperature range: -25...85°C
Material: PUR halogen-free
Rated current (at 30°): 2 A

included in: G-SEK100-O-1FE12-2000-OE
G-MEK063-O-4PR4-1FE12-2000-OE

spare part: EG-MEK-FEB12-2000OE

FES12
Electric strip, male
Spring contacts
12 poles (male)
Strip 2x 6 rows
Spring force: 0,6N at 0,7mm
Rated current per pole: 2A
Contact resistance < 20mΩ
Contact spacing: 2,54mm
Gilded
Solder connection
Max stroke: 2,4mm

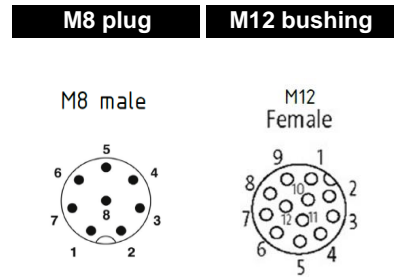

40-M8
40mm cable, circular connector M8 plug

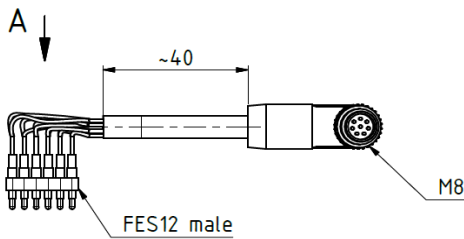

pin assignment	
1	white
2	brown
3	green
4	yellow
5	grey
6	pink
7	blue
8	red
9	---
10	---
11	---
12	---

M8 plug
8 poles (male)
Cable: drag chain suitable
Operating voltage: max 30 V
Rated current (at 30°): 1,5 A
Temperature range: -25...85°C
Cable: PUR halogen-free

included in: G-SEK100-U-1FE12-40-M8
G-MEK063-U-4PR4-1FE12-40-M8

spare part: EG-MEK-FES12-40-M8-SW

300-M12
300mm cable, circular connector M12 bushing

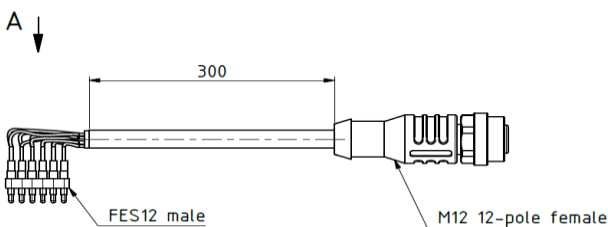

FES12 male	colour	M12 fem.
1	white	3
2	brown	1
3	green	4
4	yellow	6
5	grey	8
6	pink	5
7	blue	2
8	red	9
9	black	7
10	violet	10
11	grey/pink	11
12	blue/red	12

M12 bushing
12 poles (female)
Cable: drag chain suitable
12 x 0,14mm ² , Ø5,6
According to IEC-61076-2-104
Operating voltage: max 30 V
Rated current (at 30°): 1,5 A
Insulation resistance: ≥10 ³ Ω
Temperature range: -25...85°C
Cable: PUR halogen-free

included in: G-SEK100-U-1FE12-300-M12
G-MEK063-U-4PR4-1FE12-300-M12

spare part: EG-MEK-FES12-300-M12

2000-OE
2000mm cable, open end

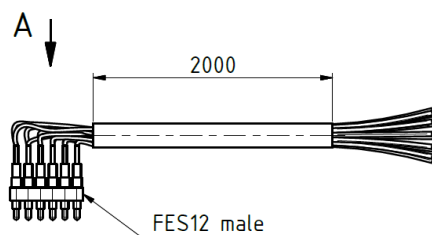

pin assignment	
1	white
2	brown
3	green
4	yellow
5	grey
6	pink
7	blue
8	red
9	black
10	violet
11	grey-pink
12	blue-red

Open end
12 poles
Cable: drag chain suitable
Outer-Ø (D): 5,6 ± 0,2mm
Nominal voltage: ≤300V
Bending radius:
- fixed installation: >5 x D
- in motion: >10 x D
Wire cross-section: 12 x 0,14mm ²
Insulation resistance: ≥10 ³ Ω
Temperature range: -25...85°C
Material: PUR halogen-free
Rated current (at 30°): 2 A

included in: G-SEK100-U-1FE12-2000-OE
G-MEK063-U-4PR4-1FE12-2000-OE
spare part: EG-MEK-FES12-2000OE

IKS12

- Insulating body with pins
- 12 poles (male)
- Rated current per pole: 9A
- Contact resistance < 3mΩ

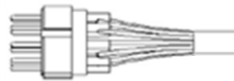

M8 bushing

M12 plug

M8 female

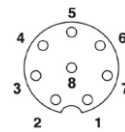

M12 Male

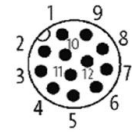

300-M8

300mm cable, circular connector M8 bushing

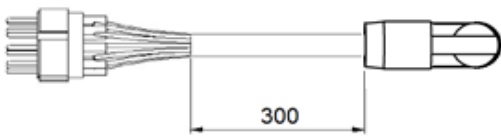

pin assignment	
1	white
2	brown
3	green
4	yellow
5	grey
6	pink
7	blue
8	red
9	---
10	---
11	---
12	---

M8 bushing

- 8 poles (female)
- Cable: drag chain suitable
- According to IEC-61076-2-104
- Operating voltage: max 30 V
- Rated current (at 30°): 1,5 A
- Temperature range: -25...85°C
- Cable: PUR halogen-free

included in: G-SEK100-O-1E12-300-M8
G-MEK063-O-6PM5-1E12-300-M8

spare part: EG-MEK-IKS12-300-M8-BW

300-M12

300mm cable, circular connector M12 plug

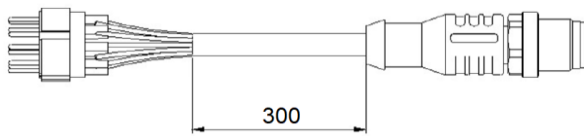

pin assignment	
1	brown
2	blue
3	white
4	green
5	pink
6	yellow
7	black
8	grey
9	red
10	violet
11	grey-pink
12	blue-red

M12 plug

- 12 poles (male)
- Cable: drag chain suitable
- 12 x 0,14mm², Ø5,6
- According to IEC-61076-2-104
- Operating voltage: max 30 V
- Rated current (at 30°): 1,5 A
- Insulation resistance: ≥10³Ω
- Temperature range: -25...85°C
- Cable: PUR halogen-free

included in: G-SEK100-O-1E12-300-M12
G-MEK063-O-6PM5-1E12-300-M12

spare part: EG-MEK-IKS12-300-M12

2000-OE

2000mm cable, open end



pin assignment	
1	brown
2	blue
3	white
4	green
5	pink
6	yellow
7	black
8	grey
9	red
10	violet
11	grey-pink
12	blue-red

Open end

- 12 poles
- Cable: drag chain suitable
- Outer-Ø (D): 5,6 ± 0,2mm
- Nominal voltage: ≤300V
- Bending radius:
 - fixed installation: >5 x D
 - in motion: >10 x D
- Wire cross-section: 12 x 0,14mm²
- Insulation resistance: ≥10³Ω
- Temperature range: -25...85°C
- Material: PUR halogen-free
- Rated current (at 30°): 2 A

included in: G-SEK100-O-1E12-2000-OE
G-MEK063-O-6PM5-1E12-2000-OE
spare part: EG-MEK-IKS12-2000-OE

IKB12
Insulating body with bushings
12 poles (female)
Rated current per pole: 9A
Contact resistance < 3mΩ

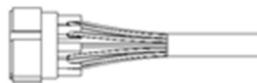

M8 plug	M12 bushing
M8 male	M12 Female

40-M8
40mm cable, circular connector M8 plug

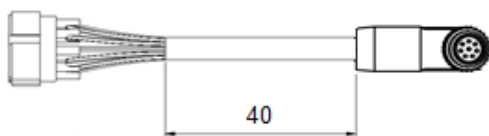

pin assignment	
1	white
2	brown
3	green
4	yellow
5	grey
6	pink
7	blue
8	red
9	---
10	---
11	---
12	---

M8 plug
8 poles (male)
Cable: drag chain suitable
Operating voltage: max 30 V
Rated current (at 30°): 1,5 A
Temperature range: -25...85°C
Cable: PUR halogen-free

included in: G-SEK100-U-1E12-40-M8
G-MEK063-U-6PM5-1E12-40-M8

spare part: EG-MEK-IKB12-40-M8-SW

300-M12
300mm cable, circular connector M12 bushing

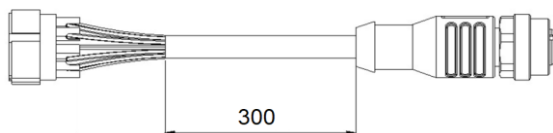

pin assignment	
1	brown
2	blue
3	white
4	green
5	pink
6	yellow
7	black
8	grey
9	red
10	violet
11	grey-pink
12	blue-red

M12 bushing
12 poles (female)
Cable: drag chain suitable
12 x 0,14mm ² , Ø5,6
According to IEC-61076-2-104
Operating voltage: max 30 V
Rated current (at 30°): 1,5 A
Insulation resistance: ≥10 ³ Ω
Temperature range: -25...85°C
Cable: PUR halogen-free

included in: G-SEK100-U-1E12-300-M12
G-MEK063-U-6PM5-1E12-300-M12

spare part: EG-MEK-IKB12-300-M12

2000-OE
2000mm cable, open end

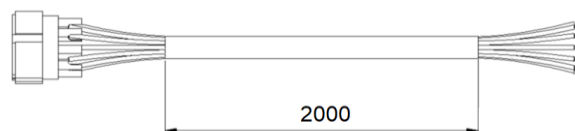

pin assignment	
1	brown
2	blue
3	white
4	green
5	pink
6	yellow
7	black
8	grey
9	red
10	violet
11	grey-pink
12	blue-red

Open end
12 poles
Cable: drag chain suitable
Outer-Ø (D): 5,6 ± 0,2mm
Nominal voltage: ≤300V
Bending radius:
- fixed installation: >5 x D
- in motion: >10 x D
Wire cross-section: 12 x 0,14mm ²
Insulation resistance: ≥10 ³ Ω
Temperature range: -25...85°C
Material: PUR halogen-free
Rated current (at 30°): 2 A

included in: G-SEK100-U-1E12-2000-OE
G-MEK063-U-6PM5-1E12-2000-OE
spare part: EG-MEK-IKB12-2000-OE