

G-SHW125

Technical specifications



Operating mode:

By operating the hand lever on the upper assembly (1), the crossway bolt is displaced radially. The crossway bolt is pressed into the bore of the lower assembly (2).

Advantages:

- Withstands high loads with low dead weight
- Intuitive operation
- Can be released and closed with one handle
- High repeat accuracy +/- 0.02 mm
- Holds up to 5,000 changing cycles
- Optional connection of an energy feed-through **SEK** for electrical and pneumatic ducts
- Interface according to DIN EN ISO 9409-1

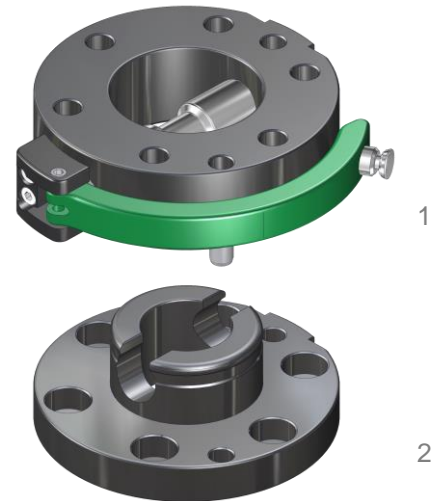

Technical specifications		SHW125
Basic material		Al. anod.
External diameter x height [mm]		125 x 50
Pitch circle diameter [mm]		100
Repeat accuracy +/- [mm]		0,02
Tension Fz [N]		1.200
Compression -Fz [kN]		377
Torsion Mz [Nm]		180
Bending Mx, My [Nm]		180
Mass [kg]	upper assembly	1,3
	lower assembly	0,55
Recommended load [kg]		40* / 55**
Locking force VF [N]		8 - 80
Locking stroke VH [mm]		0 - 1
Operating temperature range [°C]		-30 to +120
* This guideline applies to the following assumptions: Acceleration: 10 m/s², gravity distance: 100 mm, double safety		
** This guideline applies to the following assumptions: Acceleration: 5 m/s², gravity distance: 100 mm, double safety		

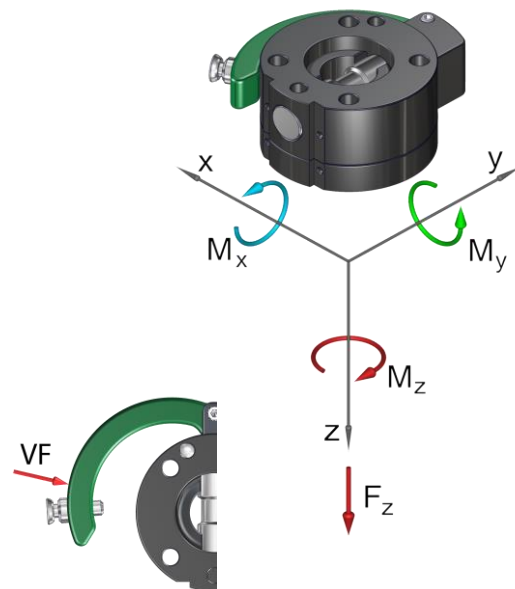

Pos.	Description
1	Upper assembly
2	Crossway bolt (CB)
3	Hand lever
4	Holder
5	Strap pin (SP)
6	Spring locking pin
7	Guiding screw
8	Index pin
9	Cylinder bolt SP
10	Cylinder bolt CB
11	Shim ring
12	Lower assembly

SHW125 Connector, drilled acc. to ISO...

G-SHW125-2OE	upper assembly, E-Mount, Al, anodized
G-SHW125-2UE	lower assembly, E-Mount, Al, anodized

