

Datum 11.11.2016

Maßstab 2:1

Zeichnungsnummer

G-GI013

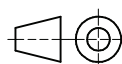

GRIP
GRIP GmbH Handhabungstechnik

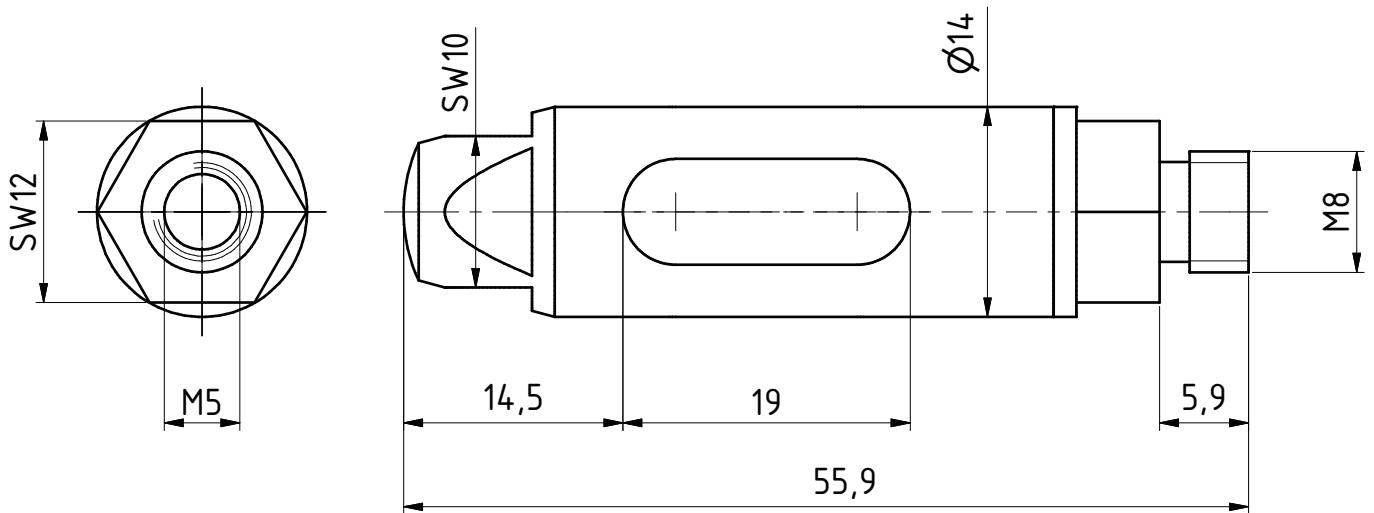

Datum 11.11.2016

Maßstab 2:1

Zeichnungsnummer

G-GI014

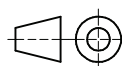

GRIP
GRIP GmbH Handhabungstechnik

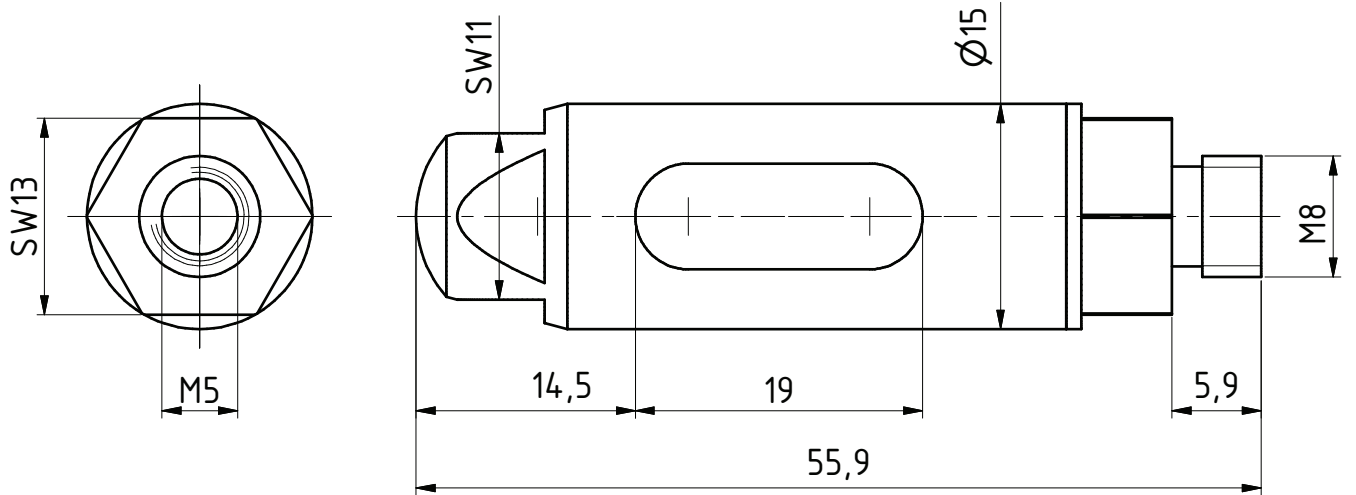

Datum 11.11.2016

Maßstab 2:1

Zeichnungsnummer

G-GI015

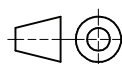

GRIP
GRIP GmbH Handhabungstechnik

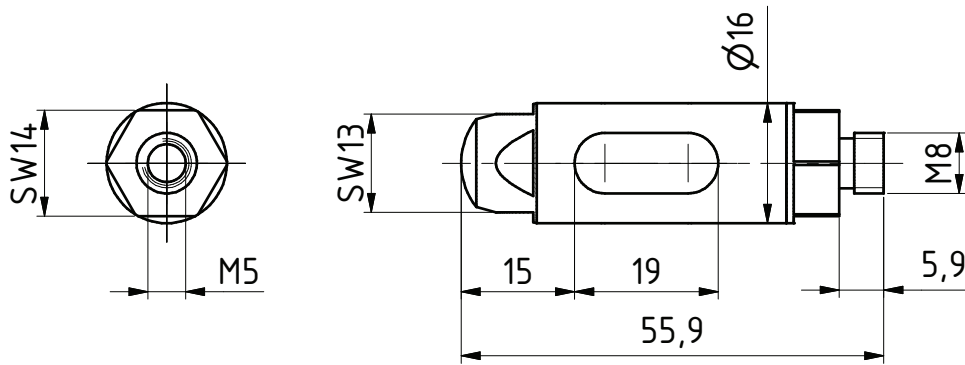

Datum 11.11.2016

Maßstab 1:1

Zeichnungsnummer

G-GI016

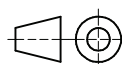

GRIP
GRIP GmbH Handhabungstechnik