

( 1 : 2 )

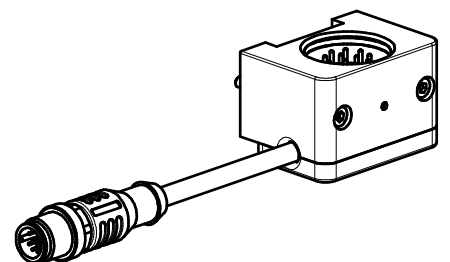

Datum 11.11.2016

Maßstab 1:1

Zeichnungsnummer

G-SEK125-0-1E12-300-M12

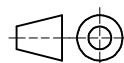

**GRIP**  
GRIP GmbH Handhabungstechnik

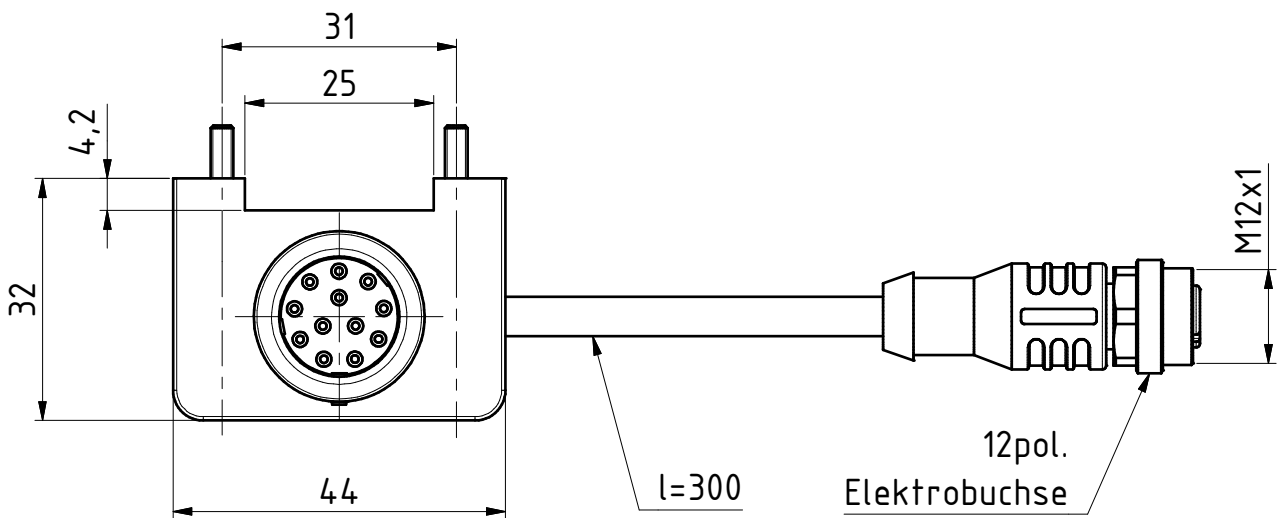
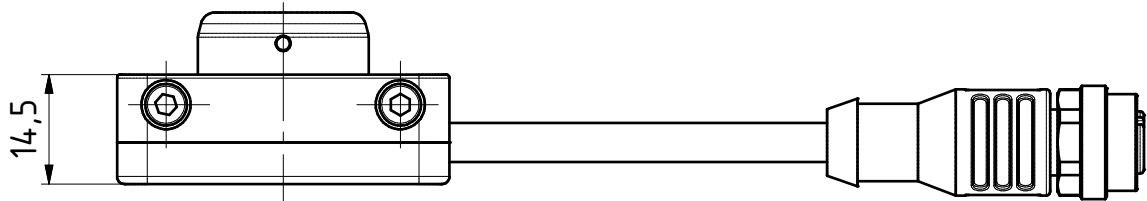
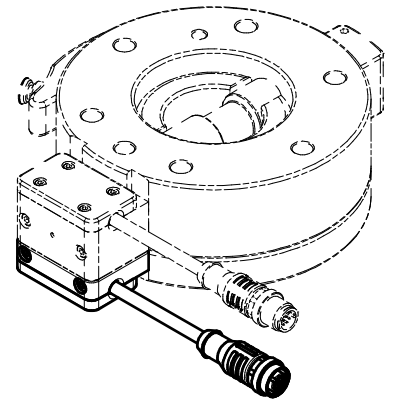

( 1 : 2 )

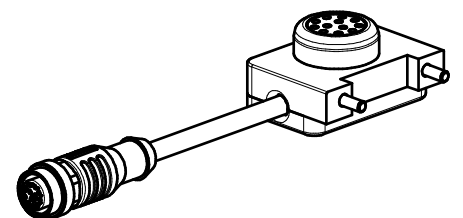

Datum 11.11.2016

Maßstab 1:1

Zeichnungsnummer

G-SEK125-U-1E12-300-M12

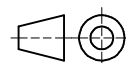

**GRIP**  
GRIP GmbH Handhabungstechnik