

Datum 10.11.2016

Maßstab 1:1

Zeichnungsnummer

G-SWA125-2Z

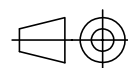

GRIP

GRIP GmbH Handhabungstechnik

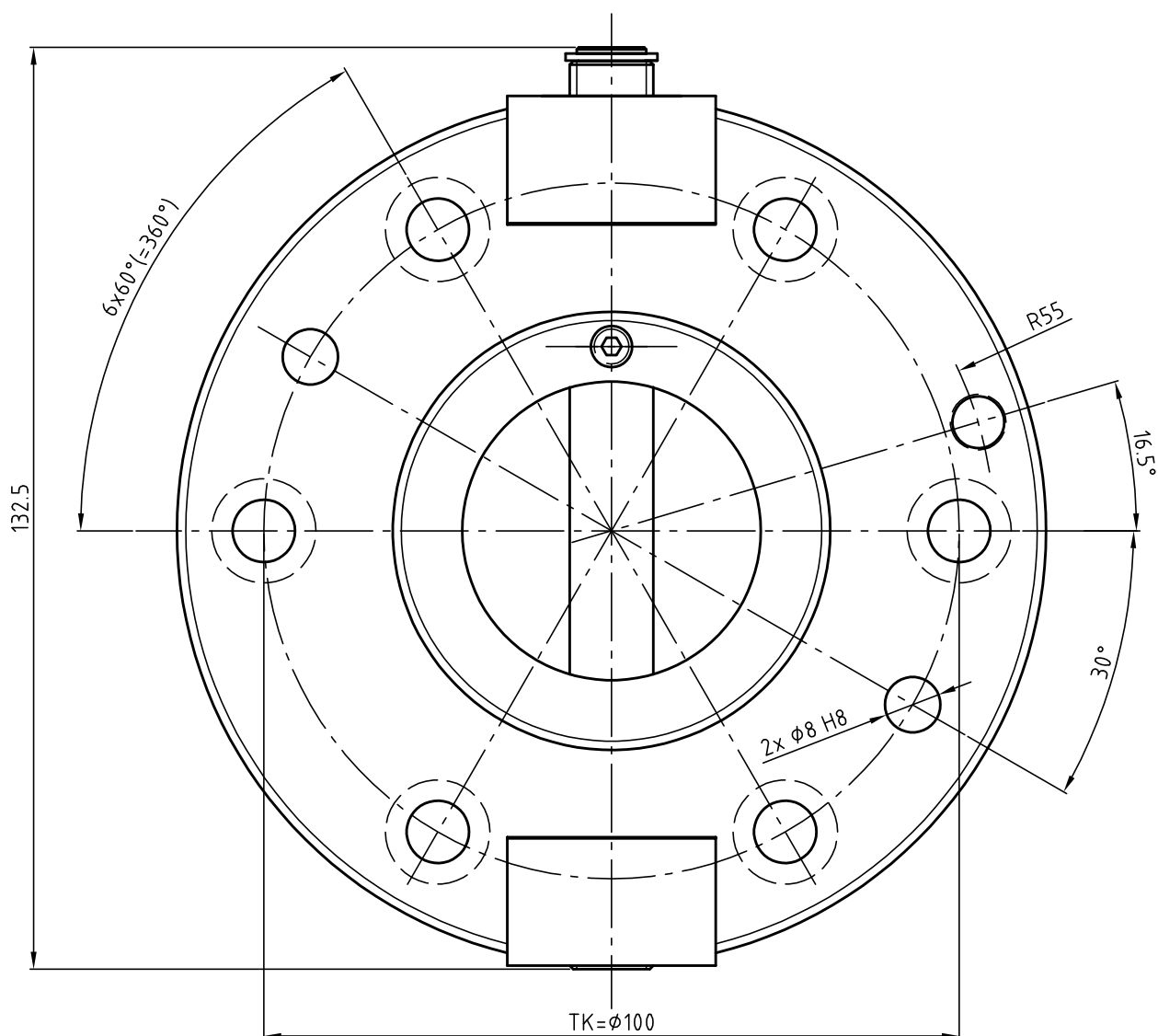
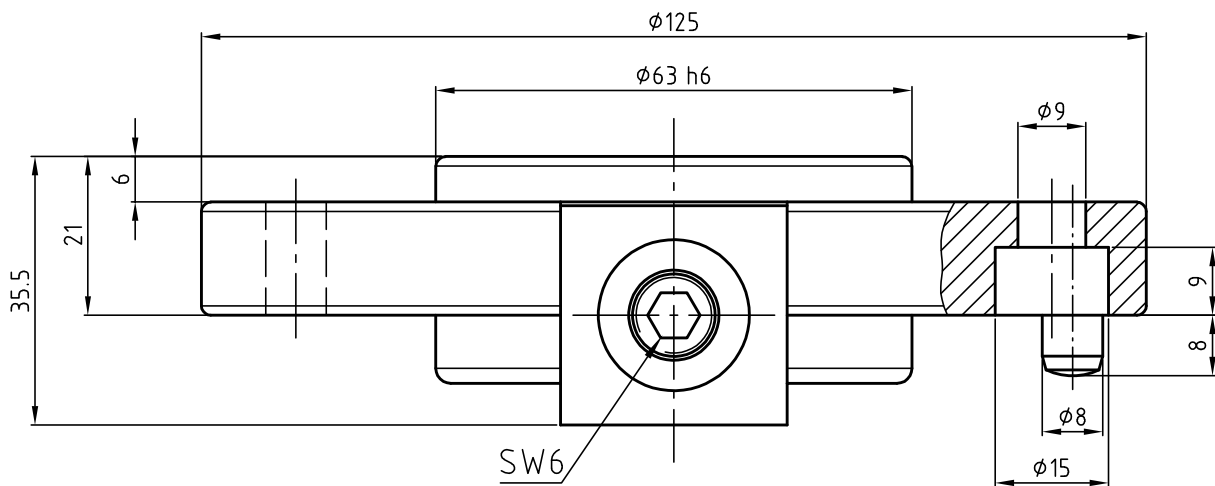

Grundmaterial	Bestellnummer Oberteil
Al. eloxiert	G-SWA125-20
Stahl	G-SWA125-20-S
St. nitriert	G-SWA125-20-N

Datum 10.11.2016

Maßstab 1:1

Zeichnungsnummer

G-SWA125-20

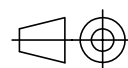

GRIP

GRIP GmbH Handhabungstechnik

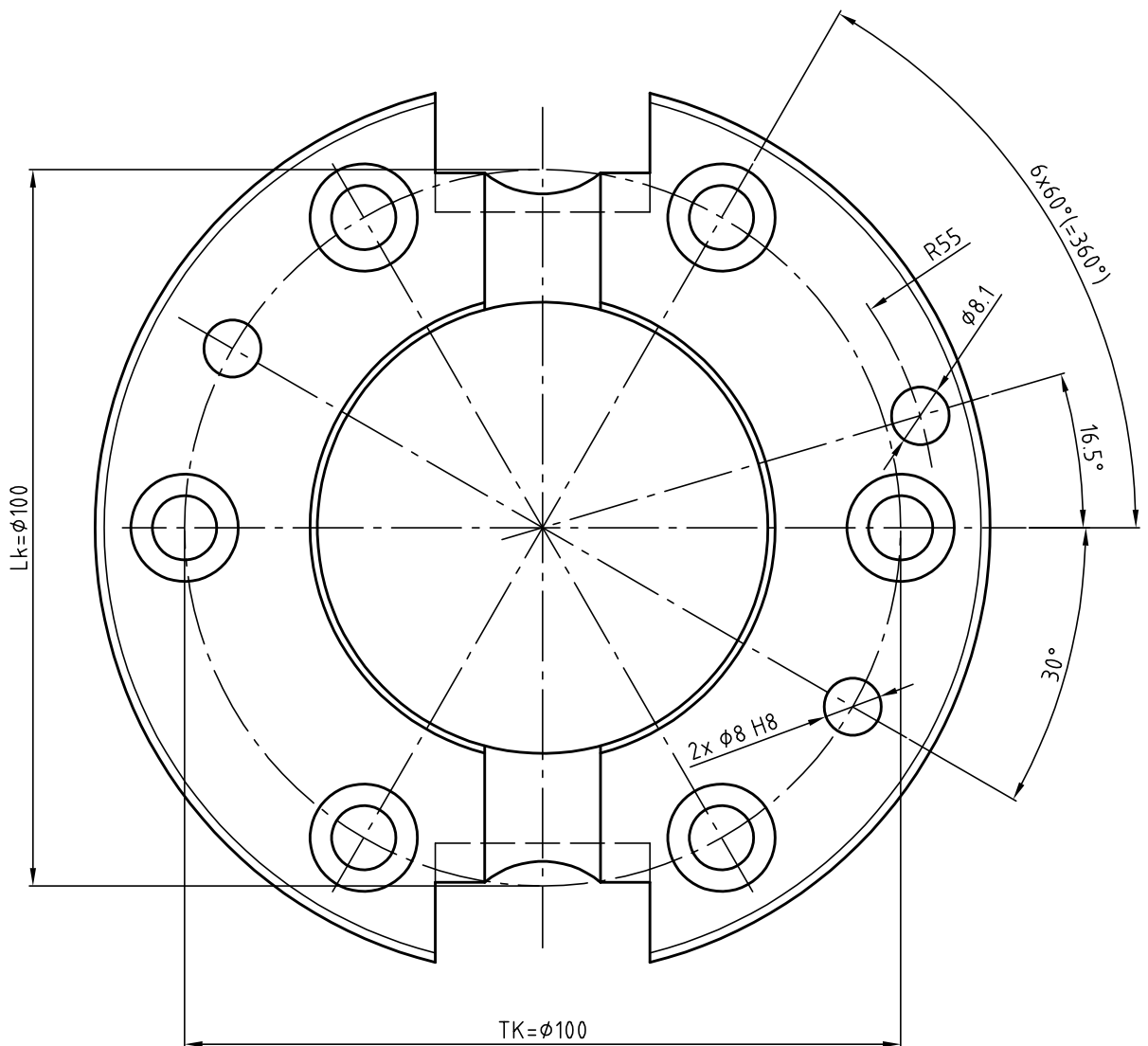
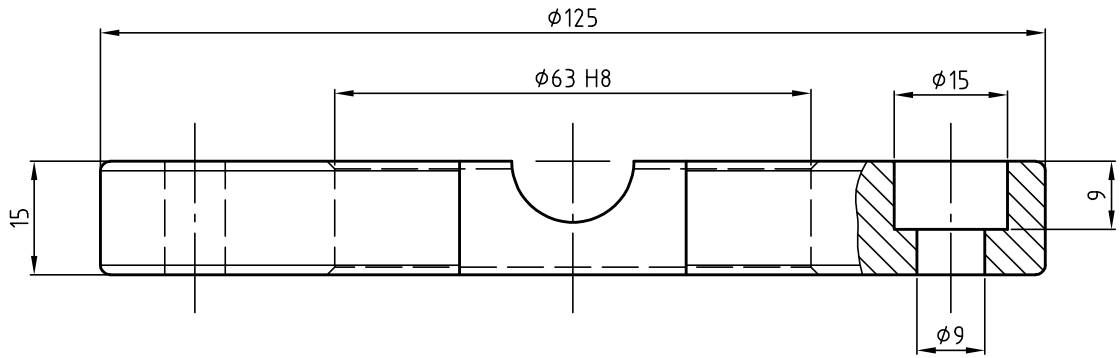

Grundmaterial	Bestellnummer Unterteil
Al. eloxiert	G-SWA125-2U
Stahl	G-SWA125-2U-S
St. nitriert	G-SWA125-2U-N

Datum 10.11.2016

Maßstab 1:1

Zeichnungsnummer

G-SWA125-2U

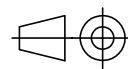

GRIP

GRIP GmbH Handhabungstechnik