

Datum 11.11.2016

Maßstab 1:1

Zeichnungsnummer

G-SHW125-2ZE

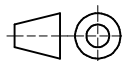

GRIP
GRIP GmbH Handhabungstechnik

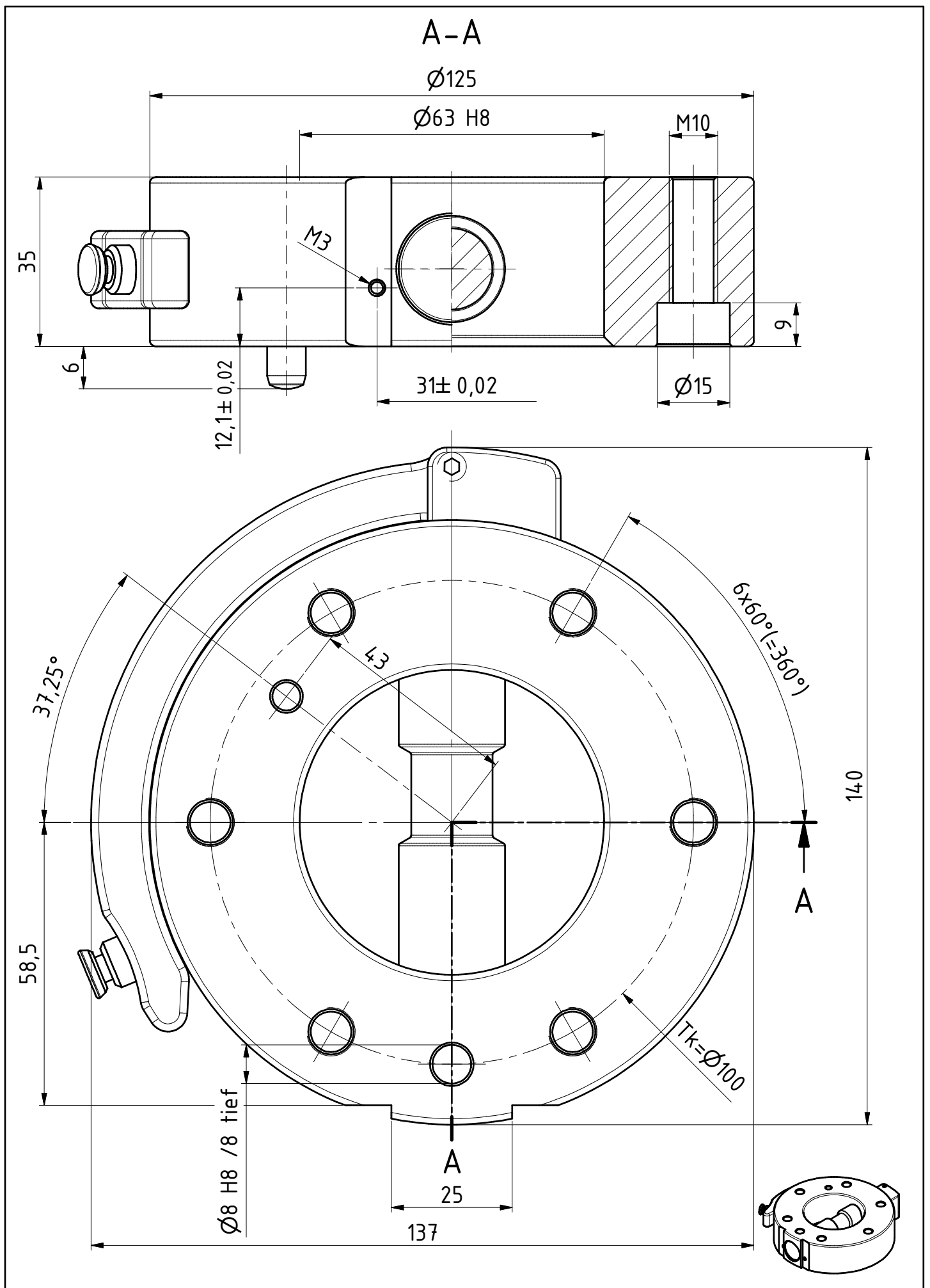

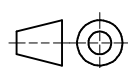
Datum 03.09.2021	Maßstab 1:1		 GRIP GmbH Handhabungstechnik
Zeichnungsnummer G-SHW125-20E			

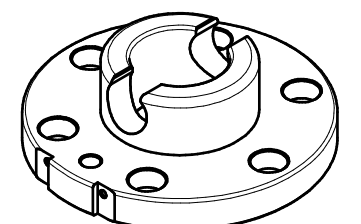
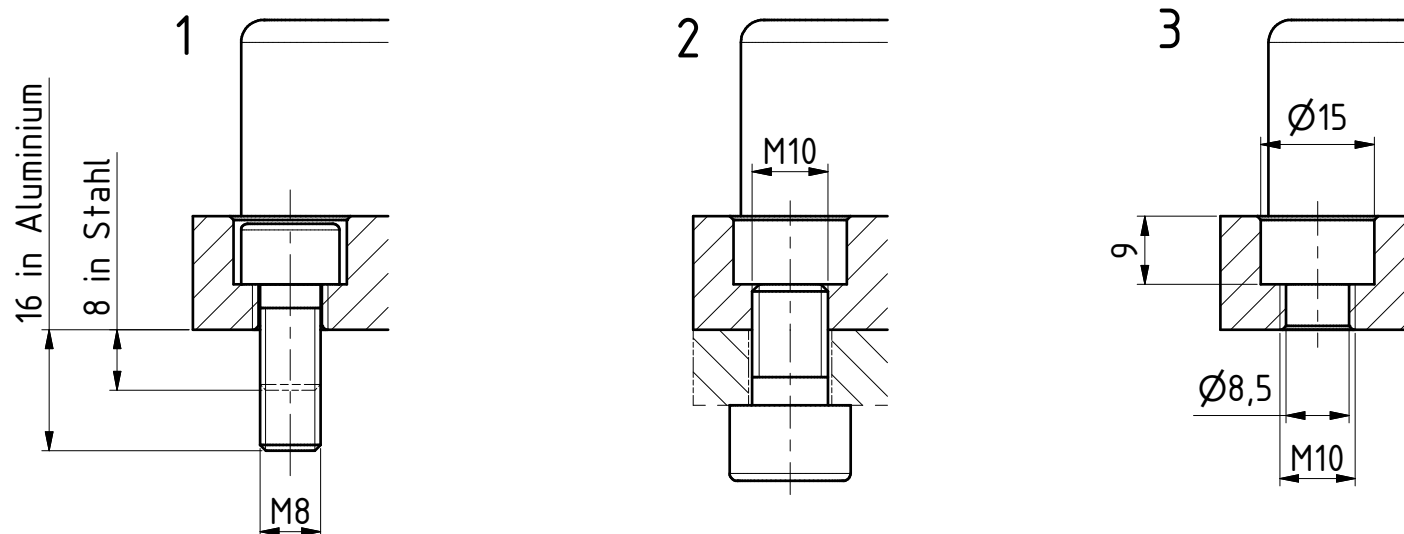
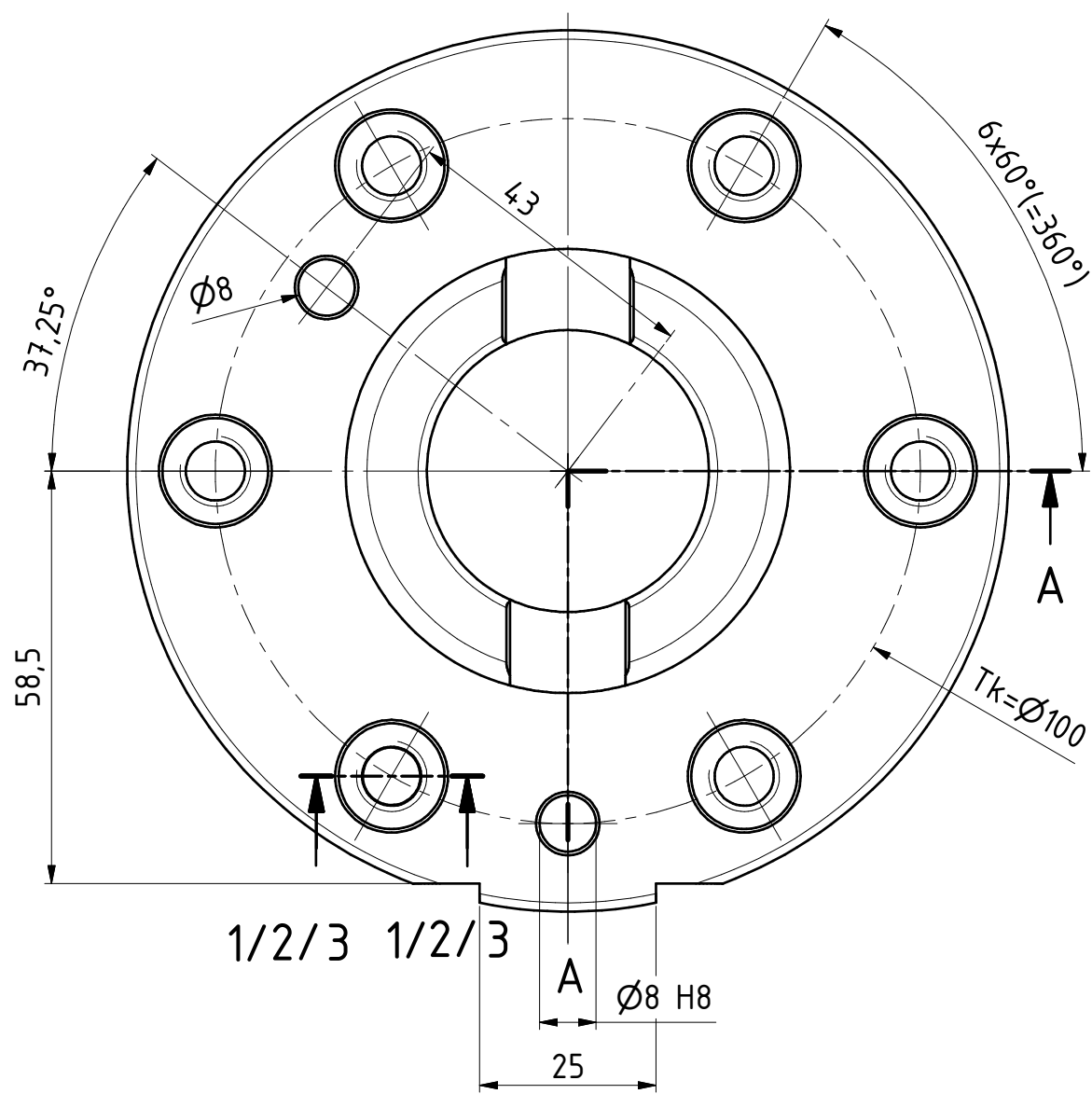
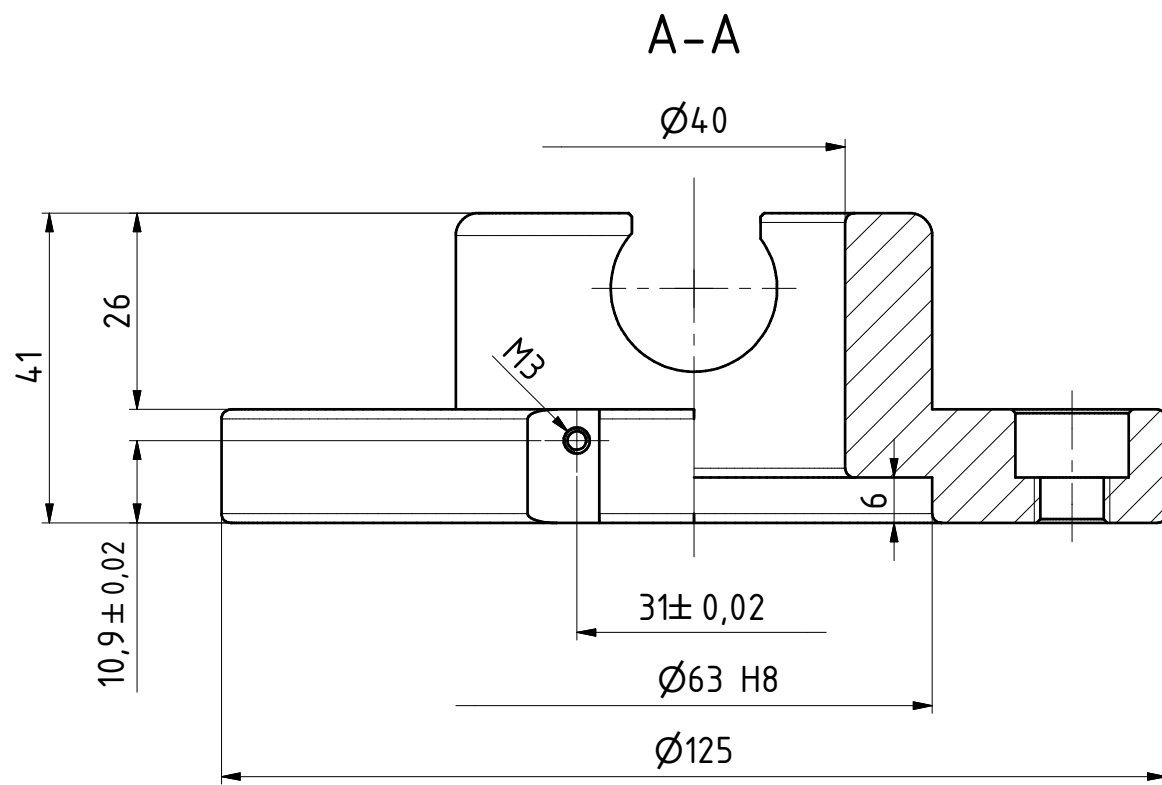

Datum 03.09.2021 Maßstab 1:1
 Zeichnungsnummer
 G-SHW125-2UE

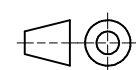

GRIP
 GRIP GmbH Handhabungstechnik